

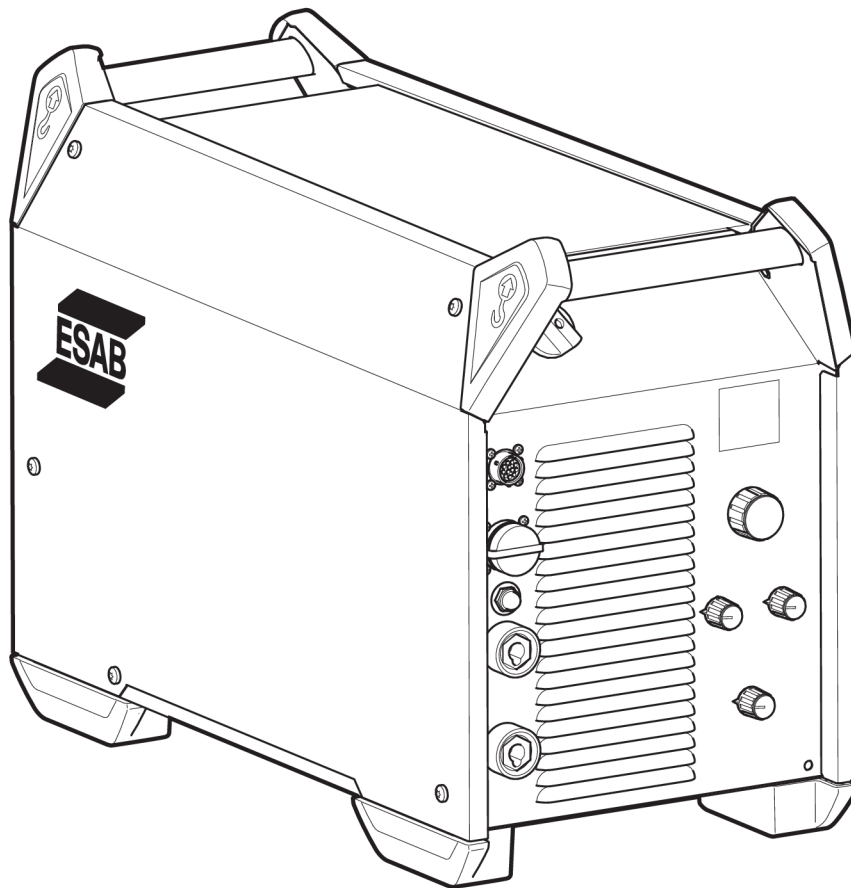

Warrior™ 500i CC/CV



Instruction manual

1	SAFETY	3
1.1	Meaning of symbols	3
1.2	Safety precautions	3
1.3	User responsibility	7
1.4	California Proposition 65 Warning.....	9
2	INTRODUCTION	11
2.1	Overview	11
2.2	Equipment	11
3	TECHNICAL DATA	12
4	INSTALLATION	14
4.1	General	14
4.2	Lifting instructions	14
4.3	Location.....	15
4.4	Main supply.....	15
5	OPERATION	18
5.1	Connections and control devices	18
5.2	Connecting welding and return cables	18
5.3	Turning the power on/off	19
5.4	Fan control	19
5.5	Symbols and functions	20
6	MAINTENANCE	23
6.1	Routine maintenance	23
6.2	Cleaning instructions.....	23
6.2.1	Cleaning procedure	24
7	TROUBLESHOOTING	25
8	ORDERING SPARE PARTS	26
	DIAGRAM	27
	ORDER NUMBERS	28
	ACCESSORIES	29

1 SAFETY

1.1 Meaning of symbols

As used throughout this manual: Means Attention! Be Alert!



DANGER!

Means immediate hazards which, if not avoided, will result in immediate, serious personal injury or loss of life.



WARNING!

Means potential hazards which could result in personal injury or loss of life.



CAUTION!

Means hazards which could result in minor personal injury.



WARNING!

Before use, read and understand the instruction manual and follow all labels, employer's safety practices and Safety Data Sheets (SDSs).



1.2 Safety precautions



WARNING!

These Safety Precautions are for your protection. They summarize precautionary information from the references listed in the Additional Safety Information section. Before performing any installation or operating procedures, be sure to read and follow the safety precautions listed below as well as all other manuals, material safety data sheets, labels, etc. Failure to observe Safety Precautions can result in injury or death.



PROTECT YOURSELF AND OTHERS

Some welding, cutting and gouging processes are noisy and require hearing protection. The arc, like the sun, emits ultraviolet (UV) and other radiation and can injure the skin and eyes. Hot metal can cause burns. Training in the proper use of the processes and equipment is essential to prevent accidents. Therefore:

1. Wear a welding helmet fitted with a proper shade of filter to protect your face and eyes when welding or watching.
2. Always wear safety glasses with side shields in any work area, even if welding helmets, face shields and goggles are also required.
3. Use a face shield fitted with the correct filter and cover plates to protect your eyes, face, neck and ears from sparks and rays of the arc when operating or observing operations. Warn bystanders not to look at the arc and not to expose themselves to the rays of the electric-arc or hot metal.
4. Wear flameproof gauntlet-type gloves, heavy long-sleeve shirt, cuffless pants, high-topped shoes, and a welding helmet or cap for protection, to protect against arc rays and hot sparks or hot metal. A flameproof apron may also be desirable as protection against radiated heat and sparks.

5. Hot sparks or metal can lodge in rolled up sleeves, trouser cuffs, or pockets. Sleeves and collars should be kept buttoned and open pockets eliminated from the front of the clothing.
6. Protect other personnel from arc rays and hot sparks with a suitable non-flammable partition or curtains.
7. Use goggles over safety glasses when chipping slag or grinding. Chipped slag may be hot and can fly for long distances. Bystanders should also wear goggles over safety glasses.



FIRES AND EXPLOSIONS

The heat from flames and arcs can start fires. Hot slag or sparks can also cause fires and explosions. Therefore:

1. Protect yourself and others from flying sparks and hot metal.
2. Move all combustible materials well away from the work area or cover the materials with a protective non-flammable covering. Combustible materials include wood, cloth, sawdust, liquid and gas fuels, solvents, paints, and coating paper, etc.
3. Hot sparks or hot metal can fall through cracks or crevices in floors or wall openings and cause a hidden smoldering fire or fires on the floor below. Make certain that such openings are protected from hot sparks and metal.
4. Do not weld, cut, or perform other hot work until the work piece has been completely cleaned so that there are no substances on the work piece which might produce flammable or toxic vapors. Do not perform hot work on closed containers, they may explode.
5. Have fire extinguishing equipment handy for instant use, such as a garden hose, water pail, sand bucket, or portable fire extinguisher. Be sure you are trained in its use.
6. Do not use equipment beyond its ratings. For example, an overloaded welding cable can overheat and create a fire hazard.
7. After completing work, inspect the work area to make sure there are no hot sparks or hot metal that could cause a fire later. Use fire watchers when necessary.



ELECTRICAL SHOCK

Contact between live electrical parts and earth can cause severe injury or death. DO NOT use AC welding current in damp areas, if movement is confined, or if there is danger of falling. Therefore:

1. Be sure the power source frame (chassis) is connected to the earth system of the input power.
2. Connect the workpiece to a good electrical earth.
3. Connect the work cable to the workpiece. A poor or missing connection can expose you or others to a fatal shock.
4. Use well-maintained equipment. Replace worn or damaged cables.
5. Keep everything dry, including clothing, work area, cables, torch/electrode holder and power source.
6. Make sure that all parts of your body are insulated from both the work piece and from the ground.
7. Do not stand directly on metal or the ground while working in tight quarters or a damp area; stand on dry boards or an insulating platform and wear rubber-soled shoes.
8. Put on dry, hole-free gloves before turning on the power.
9. Turn off the power, before removing your gloves.
10. Refer to ANSI/ASC Standard Z49.1 for specific grounding recommendations. Do not mistake the work lead for a earth cable.



ELECTRIC AND MAGNETIC FIELDS

May be dangerous. Electric current flowing through any conductor causes localized Electric and Magnetic Fields (EMF). Welding and cutting current creates EMF around welding cables and welding machines. Therefore:

1. Welders having pacemakers should consult their physician before welding. EMF may interfere with some pacemakers.
2. Exposure to EMF may have other health effects which are unknown.
3. Welders should use the following procedures to minimise exposure to EMF:
 - a) Route the electrode and work cables together. Secure them with tape when possible.
 - b) Never coil the torch or work cable around your body.
 - c) Do not place your body between the torch and work cables. Route cables on the same side of your body.
 - d) Connect the work cable to the workpiece as close as possible to the area being welded.
 - e) Keep welding power source and cables as far away from your body as possible.



FUMES AND GASES

Fumes and gases can cause discomfort or harm, particularly in confined spaces. Shielding gases can cause asphyxiation. Therefore:

1. Keep your head out of the fumes. Do not breathe the fumes and gases.
2. Always provide adequate ventilation in the work area by natural or mechanical means. Do not weld, cut or gouge on materials such as galvanized steel, stainless steel, copper, zinc, lead, beryllium or cadmium unless positive mechanical ventilation is provided. Do not breathe fumes from these materials.
3. Do not operate near degreasing and spraying operations. The heat or arc can react with chlorinated hydrocarbon vapors to form phosgene, a highly toxic gas, and other irritant gases.
4. If you develop momentary eye, nose or throat irritation while operating, this is an indication that ventilation is not adequate. Stop work and take necessary steps to improve ventilation in the work area. Do not continue to operate if physical discomfort persists.
5. Refer to ANSI/ASC Standard Z49.1 for specific ventilation recommendations.



CYLINDER HANDLING

Cylinders, if mishandled, can rupture and violently release gas. A sudden rupture of cylinder valve or relief device can injure or kill. Therefore:

1. Locate cylinders away from heat, sparks and flames. Never strike an arc on a cylinder.
2. Use the proper gas for the process and use the proper pressure reducing regulator designed to operate from the compressed gas cylinder. Do not use adapters. Maintain hoses and fittings in good condition. Follow the manufacturer's operating instructions for mounting a regulator to a compressed gas cylinder.
3. Always secure cylinders in an upright position, by chain or strap, to suitable hand trucks, undercarriages, benches, wall, post or racks. Never secure cylinders to work tables or fixtures where they may become part of an electrical circuit.
4. When not in use, keep cylinder valves closed. Have valve protection cap in place if regulator is not connected. Secure and move cylinders by using suitable hand trucks.



MOVING PARTS

Moving parts, such as fans, rotors and belts can cause injury. Therefore:

1. Keep all doors, panels, guards and covers closed and securely in place.
2. Have only qualified people remove covers for maintenance and troubleshooting as necessary
3. Keep hands, hair, loose clothing and tools away from moving parts.
4. Reinstall panels or covers and close doors when service is finished and before starting the unit.



WARNING!

FALLING EQUIPMENT CAN INJURE

- Only use lifting eye to lift unit. Do NOT use running gear, gas cylinders or any other accessories.
- Use equipment of adequate capacity to lift and support unit.
- If using lift forks to move unit, be sure forks are long enough to extend beyond opposite side of unit.
- Keep cables and cords away from moving vehicles when working from an aerial location.



WARNING!

EQUIPMENT MAINTENANCE

Faulty or improperly maintained equipment can cause injury or death.

Therefore:

1. Always have qualified personnel perform the installation, troubleshooting and maintenance work. Do not perform any electrical work unless you are qualified to perform such work.
2. Before performing any maintenance work inside a power source, disconnect the power source from the incoming electrical power.
3. Maintain cables, earthing wire, connections, power cord and power supply in safe working order. Do not operate any equipment in faulty condition.
4. Do not abuse any equipment or accessories. Keep equipment away from heat sources such as furnaces, wet conditions such as water puddles, oil or grease, corrosive atmospheres and inclement weather.
5. Keep all safety devices and cabinet covers in position and in good repair.
6. Use equipment only for its intended purpose. Do not modify it in any manner.

**CAUTION!****ADDITIONAL SAFETY INFORMATION**

For more information on safe practices for electric arc welding and cutting equipment, ask your supplier for a copy of “Precautions and Safe Practices for Arc Welding, Cutting and Gouging”, Form 52-529.

The following publications are recommended:

- ANSI/ASC Z49.1 - “Safety in Welding and Cutting”
- AWS C5.5 - “Recommended Practices for Gas Tungsten Arc Welding”
- AWS C5.6 - “Recommended Practices for Gas Metal Arc welding”
- AWS SP - “Safe practices” - Reprint, Welding Handbook
- ANSI/AWS F4.1 - “Recommended Safe Practices for Welding and Cutting of Containers That Have Held Hazardous Substances”
- OSHA 29 CFR 1910 - "Safety and health standards"
- CSA W117.2 - "Code for safety in welding and cutting"
- NFPA Standard 51B, “Fire Prevention During Welding, Cutting, and Other Hot Work”
- CGA Standard P-1, “Precautions for Safe Handling of Compressed Gases in Cylinders”
- ANSI Z87.1, "Occupational and Educational Personal Eye and Face Protection Devices"

1.3 User responsibility

Users of ESAB equipment have the ultimate responsibility for ensuring that anyone who works on or near the equipment observes all the relevant safety precautions. Safety precautions must meet the requirements that apply to this type of equipment. The following recommendations should be observed, in addition to the standard regulations that apply to the workplace.

All work must be carried out by trained personnel well-acquainted with the operation of the equipment. Incorrect operation of the equipment may lead to hazardous situations, which could result in injury to the operator and damage to the equipment.

1. Anyone who uses the equipment must be familiar with:
 - its operation
 - the location of emergency stops
 - its function
 - the relevant safety precautions
 - welding and cutting or other applicable operation of the equipment
2. The operator must ensure that:
 - no unauthorized person is within the working area of the equipment when it is started up
 - no-one is unprotected when the arc is struck or work is started with the equipment
3. The workplace must:
 - be suitable for the purpose
 - be free from drafts

4. Personal safety equipment:
 - Always wear recommended personal safety equipment, such as safety glasses, flame-proof clothing, safety gloves
 - Do not wear loose-fitting items, such as scarves, bracelets, rings, etc., which could become trapped or cause burns
5. General precautions:
 - Make sure the return cable is connected securely
 - Work on high voltage equipment **may only be carried out by a qualified electrician**
 - Appropriate fire extinguishing equipment must be clearly marked and close at hand
 - Lubrication and maintenance must **not** be carried out on the equipment during operation

**WARNING!**

Arc welding and cutting may cause injury to yourself and others. Take precautions when welding and cutting.

**ELECTRIC SHOCK - Can kill**

- Install and ground the unit in accordance with instruction manual.
- Do not touch live electrical parts or electrodes with bare skin, wet gloves, or wet clothing.
- Insulate yourself from work and ground.
- Ensure your working position is safe

**ELECTRIC AND MAGNETIC FIELDS - Pose health risks**

- Welders with pacemakers fitted should consult their doctor before welding. EMF may interfere with some pacemakers.
- Exposure to EMF may have other health effects which are unknown.
- Welders should use the following procedures to minimize exposure to EMF:
 - Route the electrode and work cables together on the same side of your body. Secure them with tape when possible. Do not place your body between the torch and work cables. Never coil the torch or work cable around your body. Keep the welding power source and cables as far away from your body as possible.
 - Connect the work cable to the workpiece as close as possible to the area being welded.

**FUMES AND GASES - Can be dangerous to your health**

- Keep your head out of the fumes.
- Use ventilation, extraction at the arc, or both, to take fumes and gases away from your breathing zone and the general area.

**ARC RAYS - Can injure eyes and burn skin**

- Protect your eyes and body. Use the correct welding screen and filter lens and wear protective clothing.
- Protect bystanders with suitable screens or curtains.

**NOISE - Excessive noise can damage hearing**

Protect your ears. Use ear defenders or other hearing protection.



MOVING PARTS - Can cause injuries

- Keep all doors, panels, guards, and covers closed and securely in place.
- Have only qualified people remove covers for maintenance and troubleshooting as necessary.
- Keep hands, hair, loose clothing and tools away from moving parts.
- Reinstall panels or covers and close doors when service is finished and before starting the unit.



FIRE HAZARD

- Sparks (spatter) can cause a fire. Make sure there are no inflammable materials nearby.
- Do not use on closed containers.



CAUTION!

This product is solely intended for arc welding.



CAUTION!

Class A equipment is not intended for use in residential locations where the electrical power is provided by the public low-voltage supply system. There may be potential difficulties in ensuring electromagnetic compatibility of class A equipment in such locations, due to conducted as well as radiated disturbances.

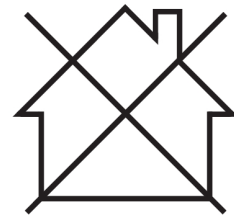

NOTE!

Dispose of electronic equipment at the recycling facility!

In observance of European Directive 2012/19/EC on Waste Electrical and Electronic Equipment and its implementation in accordance with national law, electrical and/or electronic equipment that has reached the end of its life must be disposed of at a recycling facility.

As the person responsible for the equipment, it is your responsibility to obtain information on approved collection stations.

For further information contact the nearest ESAB dealer.

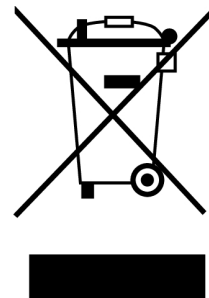

1.4 California Proposition 65 Warning



WARNING!

Welding or cutting equipment produces fumes or gases which contain chemicals known in the State of California to cause birth defects and, in some cases, cancer. (California Health & Safety Code Section 25249.5 et seq.)



WARNING!

This product can expose you to chemicals including lead, which are known to the state of California to cause cancer and birth defects or other reproductive harm. Wash hands after use.

For more information, go to www.P65Warnings.ca.gov.

ESAB has an assortment of welding accessories and personal protection equipment for purchase. For ordering information, contact your local ESAB dealer or visit us on our website.

2 INTRODUCTION

2.1 Overview

The **Warrior 500i CC/CV** is a welding power source intended for GMAW welding, as well as for welding with powder-filled cored wire (FCAW-S), for GTAW welding, for welding with coated electrodes (SMAW) and arc air gouging.

The power sources are intended for use with the following wire feed units:

- RobustFeed PRO
- RobustFeed AVS
- RobustFeed AVS ECHO
- Warrior Feed 304
- Warrior Feed 304w

ESAB accessories for the product can be found in the "ACCESSORIES" chapter of this manual.

2.2 Equipment

The power source is supplied with:

- 5 m (16 ft.) return cable with earth clamp
- Instruction manual
- Quick start guide
- Safety instruction

3 TECHNICAL DATA

Warrior 500i CC/CV	
Mains voltage	380 V; 440 V; 460 V; 575 V \pm 10%, 3~ 50/60 Hz
Primary current	
I_{max} GMAW - MIG	38 A
I_{max} GTAW - TIG	31 A
I_{max} SMAW - MMA	38 A
Idle power	40 W
Setting range	
GMAW - MIG flat characteristic	16 A/15 V-500 A/39 V
GTAW - TIG drooping characteristic	5 A/10 V-500 A/30 V
SMAW - MMA drooping characteristic	16 A/20 V-500 A/40 V
Permissible load at GMAW	
60% duty cycle	500 A/39 V
100% duty cycle	400 A/34 V
Permissible load at GTAW	
60% duty cycle	500 A/30 V
100% duty cycle	400 A/26 V
Permissible load at SMAW	
60% duty cycle	500 A/40 V
100% duty cycle	400 A/36 V
Power factor at maximum current	
GMAW	0.87
GTAW	0.83
SMAW	0.87
Efficiency at maximum current	
GMAW	90%
GTAW	88%
SMAW	90%
Electrode types	Basic Rutile Cellulosic
Open-circuit voltage without VRD function	84 V DC
Apparent power at maximum current	31.7 kVA
Active power at maximum current	22.6 kW
Operating temperature	-50 to 104°F (-10 to 40°C)
Transportation temperature	68 to 131°F (20 to 55°C)
Constant sound pressure when idling	<70 dB (A)

Warrior 500i CC/CV	
Dimensions l × w × h	28.1 x 12.8 x 18.5 inch (712 x 325 x 470 mm)
Weight (welding power source)	115.7 lbs (52.5 kg)
Insulation class	H
Enclosure class	IP 23
Application class	S

Duty cycle

The duty cycle refers to the time as a percentage of a ten-minute period that you can weld or cut at a certain load without overloading. The duty cycle is valid for 104°F (40°C).

Enclosure class

The **IP** code indicates the enclosure class, i.e. the degree of protection against penetration by solid objects or water.

Equipment marked **IP23** is intended for indoor and outdoor use.

Application class

The symbol **S** indicates that the power source is designed for use in areas with increased electrical hazard.

4 INSTALLATION

4.1 General

The installation must be carried out by a professional.

4.2 Lifting instructions

Max 80.3 kg/177 lbs

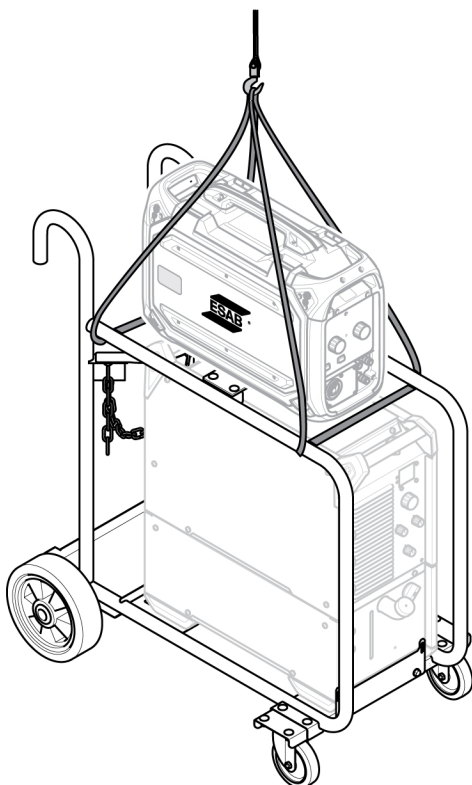
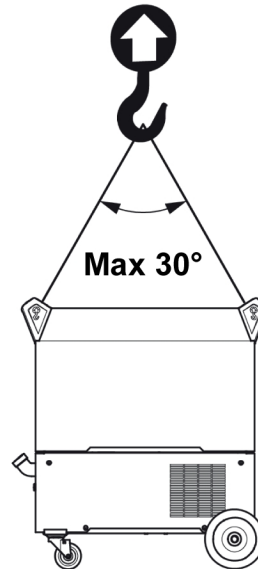
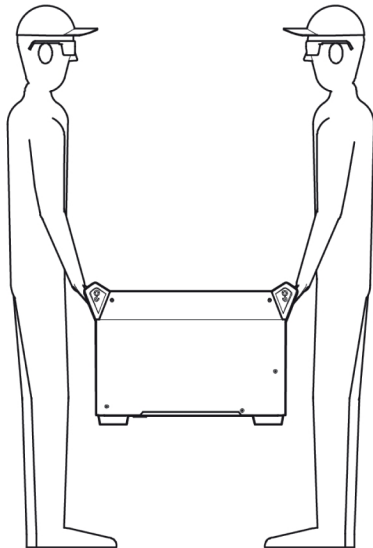



WARNING!

Secure the equipment - particularly if the ground is uneven or sloping.

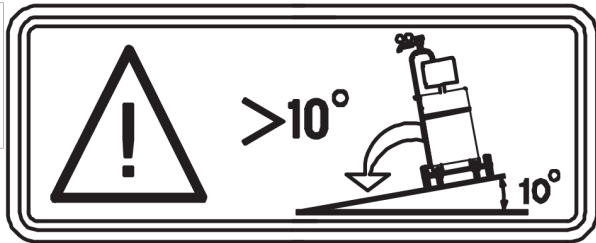

4.3 Location

Position the welding power source such that its cooling air inlets and outlets are not obstructed.

4.4 Main supply



NOTE!

Mains supply requirements

High power equipment, due to the primary current drawn from the mains supply, may influence the power quality of the grid. Therefore, connection restrictions or requirements regarding the maximum permissible mains impedance, or the required minimum supply capacity at the interface point to the public grid, may apply for some types of equipment (see technical data). In this case, it is the responsibility of the installer or user of the equipment to ensure, in consultation with the distribution network operator if necessary, that the equipment may be connected.

Make sure that the welding power source is connected to the correct supply voltage and that it is protected by the correct fuse rating. A protective ground connection must be made in accordance with regulations.

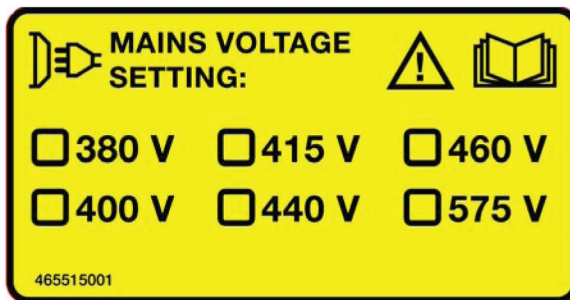

Rating plate with supply connection data

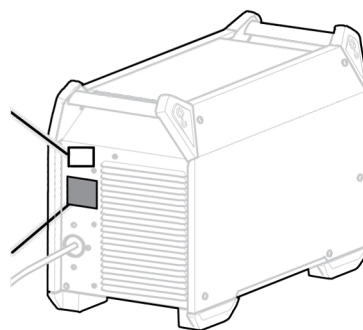

Recommended fuse sizes and minimum cable area Warrior 500i CC/CV

Warrior 500i CC/CV		
Mains voltage	380V 3~ 50/60 Hz	440 V 3~ 50/60 Hz
Mains cable area	4C 8 AWG/4G 6 mm ²	4C 8 AWG/4G 6 mm ²
Phase current I_{eff}	30 A	28 A
Fuse		
anti-surge	35 A	35 A
type C MCB	32 A	32 A

Warrior 500i CC/CV		
Mains voltage	460 V 3~ 50/60 Hz	575 V 3~ 50/60 Hz
Mains cable area	4C 8 AWG/4G 6 mm ²	4C 8 AWG/4G 6 mm ²
Phase current I_{eff}	28 A	24 A
Fuse		
anti-surge	35 A	25 A
type C MCB	32 A	25 A

**NOTE!**

The power cable areas and fuse sizes as shown above are in accordance with Swedish regulations. Use the power source in accordance with the relevant national regulations.

Supply from power generators

The power source can be supplied from different types of generators. However, some generators may not provide sufficient power for the welding power source to operate correctly. Generators with Automatic Voltage Regulation (AVR) or with an equivalent or better type of regulation, with rated power ≥ 40 kW, are recommended.

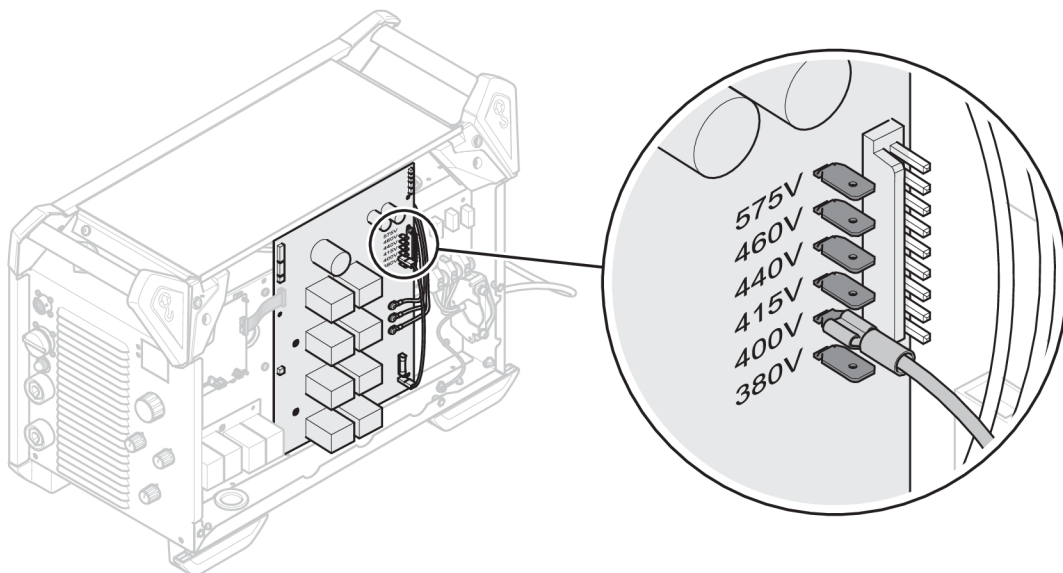
Connection instruction

The power source Warrior 500i CC/CV (0465 350 881) for USA is connected to 460 V from the factory. The power source Warrior 500i CC/CV (0465 350 887) for Canada is connected to 575 V from the factory.

If a different mains voltage is required, the cable on the printed circuit board must be moved and placed on the correct pin. See picture above. This operation must be carried out by personnel with the appropriate electrical knowledge.

Installation of electrical cable

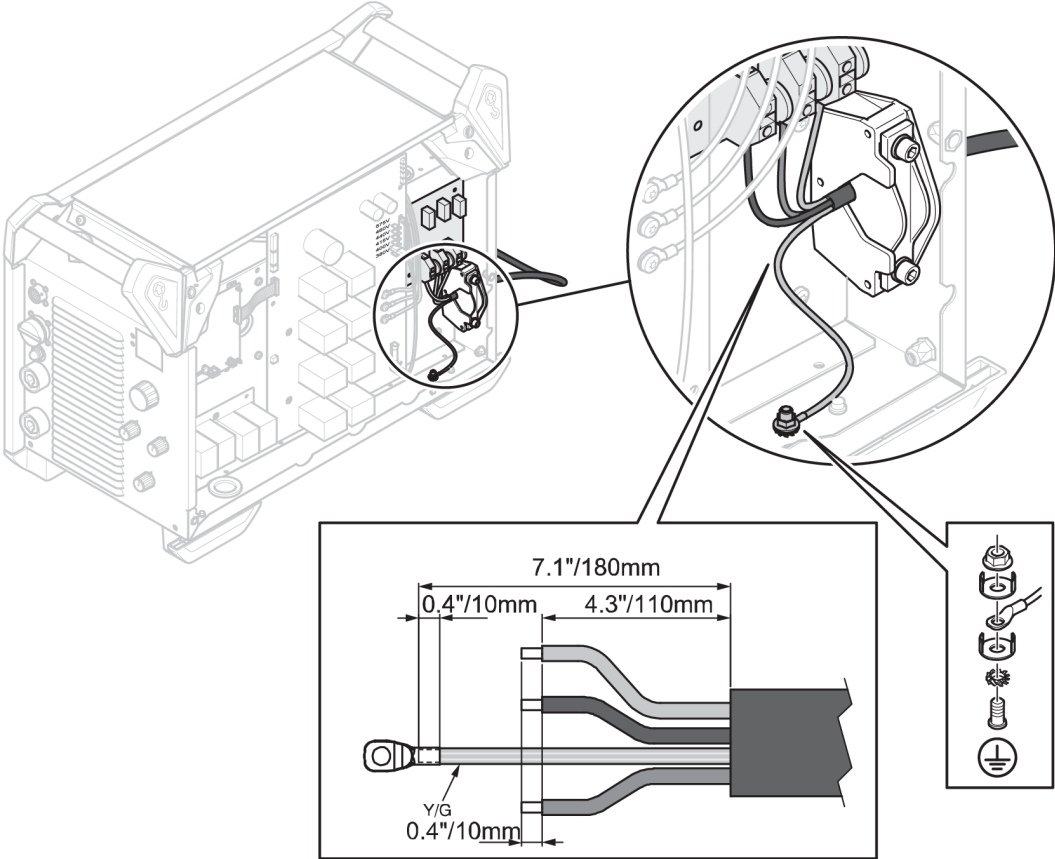

A mains cable needs to be installed. It is important that the ground connection to the bottom plate then be made in the correct way. See the picture above, for the placement order of the washers, nuts and screws.

5 OPERATION

General safety regulations for handling the equipment can be found in the "SAFETY" chapter of this manual. Read it through before you start using the equipment!



NOTE!

When moving the equipment use intended handle. Never pull the cables.



WARNING!

Electric shock! Do not touch the workpiece or the welding head during operation!

5.1 Connections and control devices

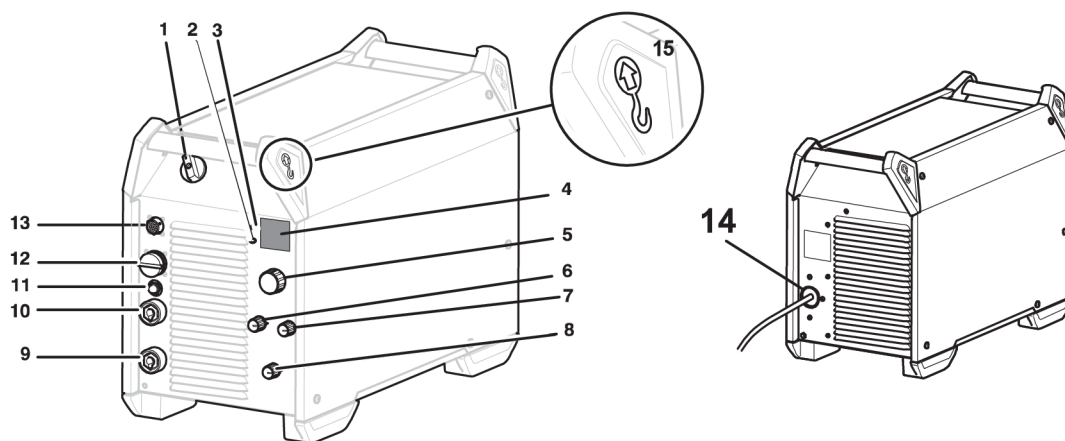

- | | |
|--|--|
| 1. Mains power supply switch, I/O | 9. Connection (-): GMAW: Return cable
GTAW: Welding torch SMAW: Return
cable or welding cable, OKC 50
(FEMALE) |
| 2. Indicator lamp, yellow, overheating | 10. Connection (+): GMAW: Welding cable
GTAW: Return cable SMAW: Welding
cable or return cable, OKC 50
(FEMALE) |
| 3. Indicator lamp, green, VRD function
(reduced open-circuit voltage) | 11. Circuit breaker, 10 A, 42 V |
| 4. Display, current (A) and voltage (V) | 12. Connection of wire feed unit, 19 pole
Amphenol connector |
| 5. Knob for setting: SMAW/GTAW:
Current (A) | 13. Connection for remote control unit
(option) |
| 6. Knob for selecting electrode type | 14. Connection for mains power supply |
| 7. Knob for inductance (GMAW) and arc
force (SMAW): | 15. Lifting eye bolt |
| 8. Knob for welding method | |

5.2 Connecting welding and return cables

The power source has two outputs, a positive terminal (+) and a negative terminal (-), for connecting welding and return cables. The output to which the welding cable is connected depends on the welding method or type of electrode used.

Connect the return cable to the other output on the power source. Secure the return cable's contact clamp to the workpiece, and make sure that there is a good contact between the workpiece and the output for the return cable on the power source.

For SMAW welding, the welding cable can be connected to the positive terminal (+) or negative terminal (-), depending on the type of electrode used. The connection polarity is stated on the electrode packaging.

Recommended maximum current values for connection set cables

At an ambient temperature of +25 °C and normal 10 minutes cycle:

Cable area	Duty cycle		Voltage loss/10 m
	100%	60%	
70 mm ²	360	400	0.25 V/100 A
95 mm ²	430	500	0.19 V/100 A

At an ambient temperature of +40 °C and normal 10 minutes cycle:

Cable area	Duty cycle		Voltage loss/10 m
	100%	60%	
70 mm ²	310	350	0.27 V/100 A
95 mm ²	370	430	0.20 V/100 A

Duty cycle

The duty cycle refers to the time as a percentage of a ten-minute period that you can weld or cut at a certain load without overloading. The duty cycle is valid for 104°F (40°C).

5.3 Turning the power on/off

Turn on the mains power by turning switch to the "I" position, see 1 in the picture above.

Turn the unit off by turning the switch to the "O" position.

Whether the mains power supply is interrupted or the power source is switched off in the normal manner, the welding data will be stored so it is available the next time the unit is started.













CAUTION!

Do not turn off the power source during welding (with load).

5.4 Fan control

The power source has a time control, this means that the fans continue to run for 6.5 minutes after welding has stopped, and the power source switches to energy-saving mode. The fans start again when welding restarts.

5.5 Symbols and functions

	Location of lifting eye	VRD	Voltage Reducing Device
	Overheating protection	Basic	Basic electrode
Rutile	Rutile electrode	Cel	Cellulosic electrode
	Arc force		Inductance
	GTAW welding (Live GTAW)		Arc air gouging
	SMAW welding		GMAW welding
	Wire feed unit Mobile feed CV (Constant voltage)		Protective ground

Voltage reducing device (VRD)

The VRD function ensures that the open-circuit voltage does not exceed 35 V when welding is not being carried out. This is indicated by a lit VRD led.

The VRD function is blocked when the system senses that welding has started.

Contact an authorized ESAB service technician to activate this function.

Overheating protection

The welding power source has overheating protection that trips if the temperature becomes too high. When this occurs, the welding current is interrupted and an overheating indication lamp is lit.

The overheating protection resets automatically when the temperature has fallen back to the normal working temperature range.

Arc force

The arc force is important in determining how the current changes in response to a change in the arc length. A lower value gives a calmer arc with less spatter.

It only applies to SMAW welding.

Inductance

Higher inductance results in a wider weld pool and less spatter. Lower inductance produces a harsher sound, but a stable, concentrated arc.

It only applies to GMAW welding.

GTAW welding

GTAW welding melts the metal of the workpiece, using an arc struck from a tungsten electrode that does not itself melt. The weld pool and electrode are protected by shielding gas.

"Live GTAW-start"

At a "Live GTAW-start", the tungsten electrode is placed against the workpiece. When the electrode is lifted away from the workpiece, the arc is struck at a limited current level.



Arc air gouging

For arc air gouging, a special electrode is used comprised of a carbon rod with a copper casing.

An arc is formed between the carbon rod and the workpiece, which melts the material. Compressed air is supplied, so the melted material is blown away.

For arc air gouging the power source must be supplemented with:

- arc air torches
- compressed air
- Return cable with clamp

Recommended for gouging

Electrode	Voltage min.	Voltage max.	Electrode Extension
6 mm (1/4")	36 V	49 V	50–76 mm (2 - 3")
8 mm (5/16")	39 V	52 V	
10 mm (3/8")	43 V	52 V	

SMAW welding

SMAW welding may also be referred to as welding with coated electrodes. Striking the arc melts the electrode, and its coating forms protective slag.

For SMAW welding, the power source must be supplemented with:

- Welding cable with electrode holder
- Return cable with clamp

GMAW and self-shielded, cored wire welding

An arc melts a continuously supplied wire. The weld pool is protected by shielding gas.

For GMAW and self-shielded, cored wire welding, the power source must be supplemented with:

5 OPERATION

- wire feed unit
- welding torch
- connection cable between power source and wire feed unit
- gas cylinder
- Return cable with clamp

6 MAINTENANCE



WARNING!

The mains supply must be disconnected during cleaning and maintenance.



CAUTION!

Only persons with appropriate electrical knowledge (authorized personnel) may remove the safety plates.



CAUTION!

The product is covered by manufacturer's warranty. Any attempt to carry out repair work by non-authorized service centers or personnel will invalidate the warranty.



NOTE!

Regular maintenance is important for safe and reliable operation.



NOTE!





Perform maintenance more often during severe dusty conditions.

Before each use, make sure that the:

- Product and cables are not damaged
- The torch is clean and not damaged

6.1 Routine maintenance

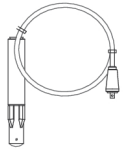
Maintenance schedule during normal conditions. Check equipment before every use.

Interval	Area to maintain		
Every 3 months	 Clean or replace unreadable labels.	 Clean weld terminals.	 Check or replace weld cables.
Every 12 months or depending on environmental conditions (by authorized service technician)	 Clean inside equipment. Use dry compressed air with 4 bar pressure.		

6.2 Cleaning instructions

To maintain the performance and increase the lifetime of the power source it is mandatory to clean the product regularly. How often depends on:

- The welding process,
- The arc time, and

- The working environment.
- the surrounding environment, that is grinding etc.

Tools needed for the cleaning procedure:

- torx screwdriver, T25 and T30
- dry compressed air at a pressure of 4 bar
- protective equipment like earplugs, safety glasses, masks, gloves, and safety shoes



CAUTION!

Make sure that the cleaning procedure is done in a suitable prepared workspace.

6.2.1 Cleaning procedure

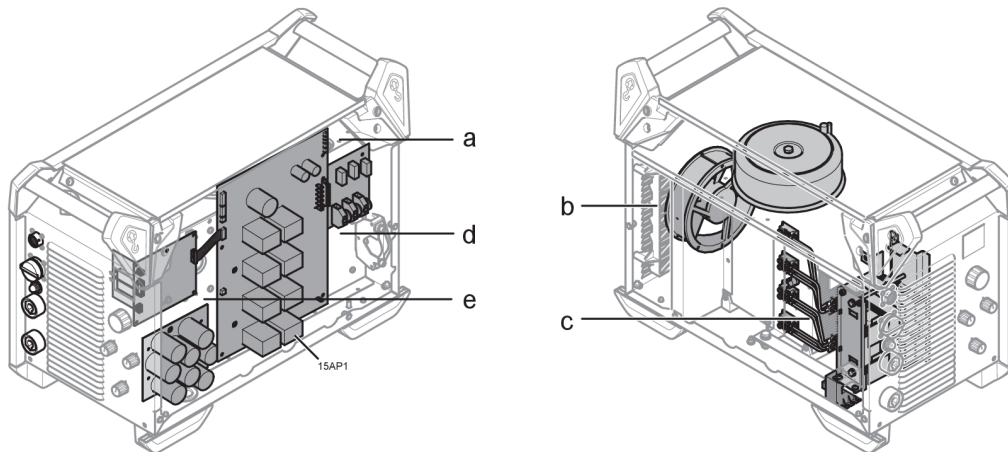

CAUTION!

The cleaning procedure should be carried out by an authorized service technician.

1. Disconnect the mains supply.
2. Wait for 4 minutes to discharge the capacitors.
3. Remove the side panels on the power source.
4. Remove the top panel on the power source.
5. Remove the plastic cover between the heat sink and fan (b).
6. Clean the power source with dry compressed air (4 bar) as follows:
 - a) The upper rear part.
 - b) From the rear panel through the secondary heat sink.
 - c) The inductor, transformer, and current sensor.
 - d) The power components side, from the rear side behind PCB 15AP1.
 - e) The PCBs at both sides.
7. Make sure that there is no dust left on any part.
8. Install the plastic cover between the heat sink and the fan (2) and make sure it is correctly fitted against the heat sink.
9. Do a test of the power source according to IEC 60974-4. Follow the procedure in section "After repair, inspection and test" in the Service manual.
10. Install the top panel on the power source.
11. Install the side panels on the power source.
12. Connect the mains supply.

7 TROUBLESHOOTING

Try these recommended checks and inspections before sending for an authorized service technician.

Type of fault	Corrective action
No arc.	<ul style="list-style-type: none"> • Check that the main power supply switch is turned on. • Check that the mains, welding, and return cables are correctly connected. • Check that the correct current value is set. • Check the electrical power supply fuses.
The welding current is interrupted during welding.	<ul style="list-style-type: none"> • Check whether the overloading protection has tripped (indicated on the front). • Check the electrical power supply fuses. • Check that the return cable is correctly fastened.
The overheating protection trips frequently.	<ul style="list-style-type: none"> • Make sure that you are not exceeding the rated data for the power source (i.e. that the unit is not being overloaded).
Poor welding performance.	<ul style="list-style-type: none"> • Check that the welding and return cables are correctly connected. • Check that the correct current value is set. • Check that the correct wire or electrode is used. • Check the electrical power supply fuses. • Check the gas pressure in the equipment connected to the power source.
"Err" on display in open circuit mode	<ul style="list-style-type: none"> • Check the electrical power supply fuses. • Check that the voltage on the voltage selection label, on the rear of the power source, is equal to the nominal mains voltage. • Restart the power source with the main switch.
ECHO communication handshake between power source and feeder not detected (applicable for AVS ECHO).	<ul style="list-style-type: none"> • Check that the welding method is set to AVS mode. • Check that the interconnection cables are connected properly. • Make sure that the power source has the "Warrior 400i / 500i upgrade kit for AVS ECHO" installed.

8 ORDERING SPARE PARTS



CAUTION!

Repair and electrical work should be performed by an authorized ESAB service technician. Use only ESAB original spare and wear parts.

Warrior 500i CC/CV is designed and tested in accordance with the international standards **IEC 60974-1**, Canadian standards **CAN/CSA-E60974-1:11** and US standards **ANSI/IEC 60974-1:2008**. Upon completion of service or repair work, it is the responsibility of the person(s) performing the work to ensure that the product still complies with the requirements of the above standards.

Spare parts and wear parts can be ordered through your nearest ESAB dealer, see the back cover of this document. When ordering, please state product type, serial number, designation and spare part number in accordance with the spare parts list. This facilitates dispatch and ensures correct delivery.

DIAGRAM

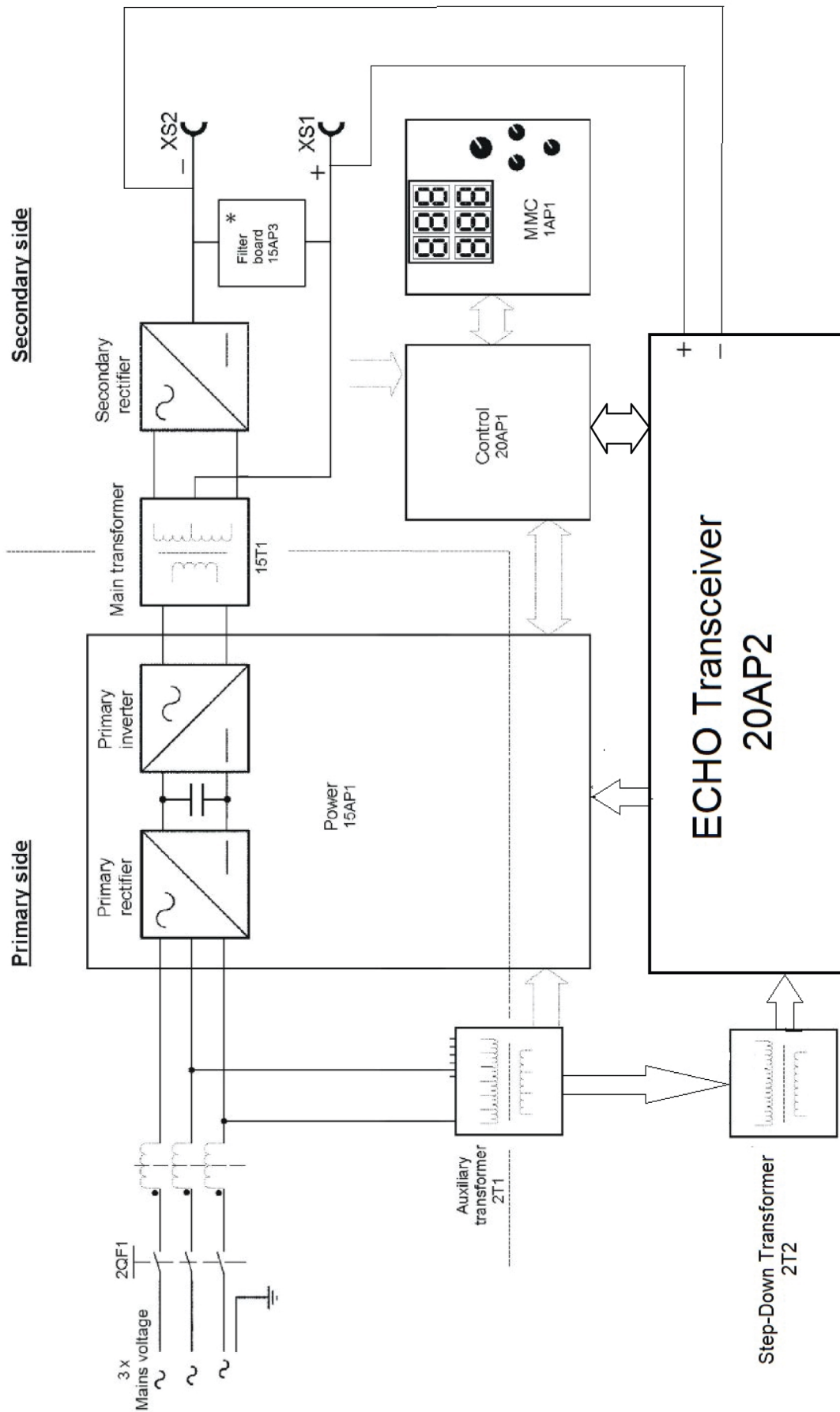



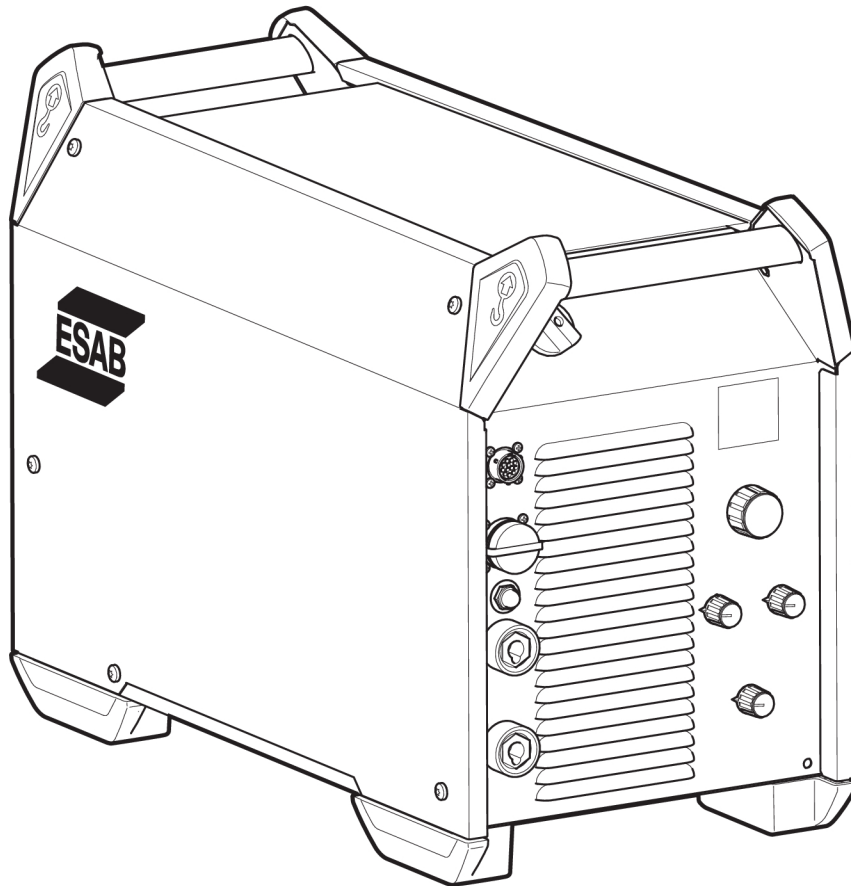

ORDER NUMBERS





Ordering number	Denomination	Type	Notes
0465 350 881	Welding power source	Warrior 500i CC/CV	460 V USA
0465 350 887	Welding power source	Warrior 500i CC/CV	575 V Canada
0459 839 084	Spare parts list		
0740 800 221	Service manual		

Technical documentation is available on the Internet at www.esab.com

ACCESSORIES

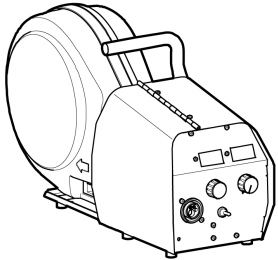
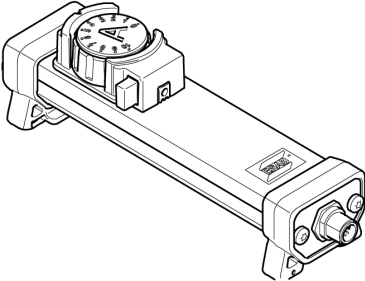
0445 800 880	Robust Feed PRO With EURO connector	
0445 800 881	Robust Feed PRO, Water With EURO connector and including torch cooling system	
0445 800 882	Robust Feed PRO Offshore With EURO connector, incl. gas flow meter and heater	
0445 800 883	Robust Feed PRO Offshore, Water With EURO connector and including torch cooling system, incl. gas flow meter and heater	
0445 800 884	Robust Feed PRO, Tweco With Tweco 4 connector	
0445 800 885	Robust Feed PRO Offshore, Tweco With Tweco 4 connector, incl. gas flow meter and heater	
0446 700 880	RobustFeed AVS without Rotameter with EURO connector	
0446 700 881	RobustFeed AVS with Rotameter with EURO connector	
0446 700 882	RobustFeed AVS without Rotameter with Tweco connector	
0446 700 883	RobustFeed AVS with Rotameter with Tweco connector	
0448 700 880	RobustFeed AVS ECHO with Rotameter with EURO connector	
0448 700 881	RobustFeed AVS ECHO with Rotameter with Tweco connector	

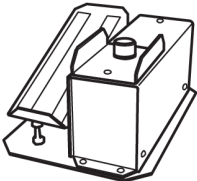
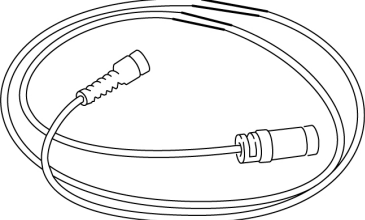
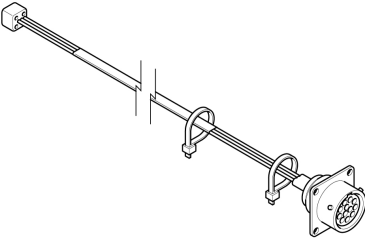
0465 250 881	Warrior™ Feed 304w , with water cooling	
0459 491 896	Remote control unit AT1 SMAW and GTAW current	
0459 491 897	Remote control unit AT1 CF SMAW and GTAW: course and fine setting of current	
0349 090 886	Foot control FS002 MMA and TIG: current	
Remote control cable 12 pole - 8 pole		
0459 552 880	5 m (16 ft.)	
0459 552 881	10 m (33 ft.)	
0459 552 882	15 m (49 ft.)	
0459 552 883	25 m (82 ft.)	
0465 424 880	Remote outlet kit	

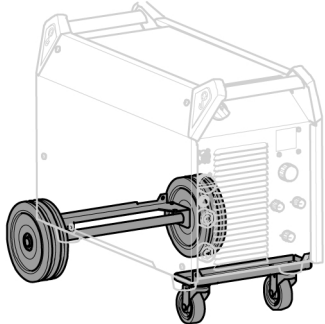
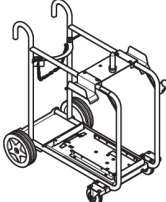
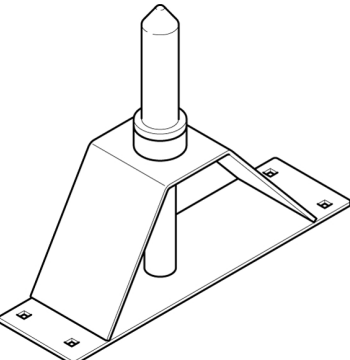
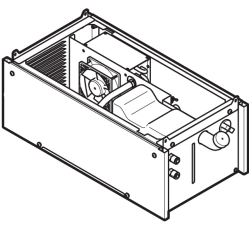
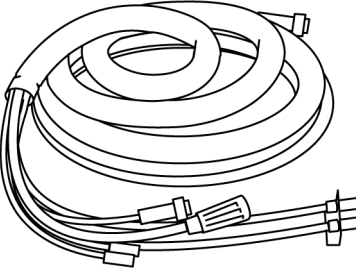
0465 416 880	Wheel kit	
0465 508 880	Trolley guide pin extension kit Used together with the trolley when the wire feed unit is equipped with wheel kit	
0465 508 880	Guide pin extension kit Used together with the trolley when the wire feed unit is equipped with wheel kit	
0465 427 880	Cooling unit	
Interconnection cable without strain relief, Air cooled, 70 mm²		
0459 836 886	2 m (7 ft.)	
0459 836 881	5 m (16 ft.)	
0459 836 882	10 m (33 ft.)	
0459 836 883	15 m (49 ft.)	
0459 836 884	25 m (82 ft.)	
0459 836 885	35 m (115 ft.)	
Interconnection cable without strain relief, Liquid cooled, 70 mm²		

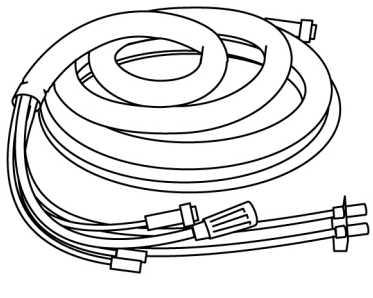
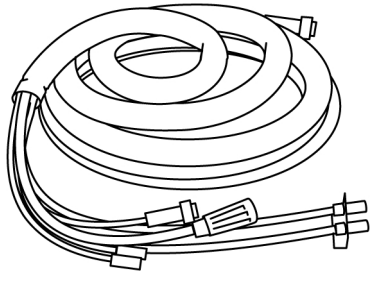
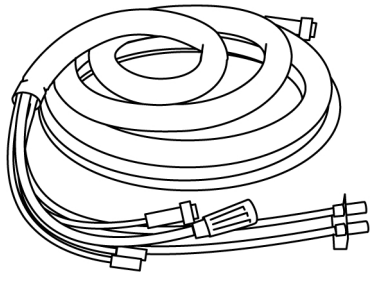
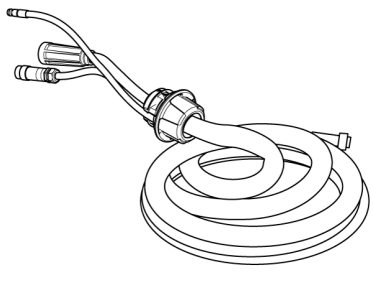
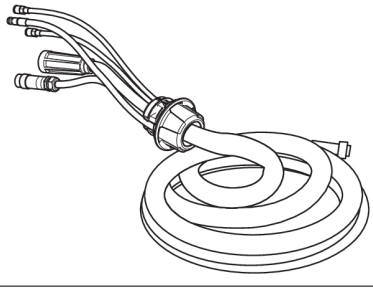
0459 836 896	2 m (7 ft.)	
0459 836 891	5 m (16 ft.)	
0459 836 892	10 m (33 ft.)	
0459 836 893	15 m (49 ft.)	
0459 836 894	25 m (82 ft.)	
0459 836 895	35 m (115 ft.)	
Interconnection cable without strain relief, Air cooled, 95 mm²		
0459 836 986	2 m (7 ft.)	
0459 836 981	5 m (16 ft.)	
0459 836 982	10 m (33 ft.)	
0459 836 983	15 m (49 ft.)	
0459 836 984	25 m (82 ft.)	
0459 836 985	35 m (115 ft.)	
Interconnection cable without strain relief, Liquid cooled, 95 mm²		
0459 836 996	2 m (7 ft.)	
0459 836 991	5 m (16 ft.)	
0459 836 992	10 m (33 ft.)	
0459 836 993	15 m (49 ft.)	
0459 836 994	25 m (82 ft.)	
0459 836 995	35 m (115 ft.)	
Interconnection cable with pre-assembled strain relief, Air cooled, 70 mm²		
0446 160 880	2 m (7 ft.)	
0446 160 881	5 m (16 ft.)	
0446 160 882	10 m (33 ft.)	
0446 160 883	15 m (49 ft.)	
0446 160 884	25 m (82 ft.)	
0446 160 885	35 m (115 ft.)	
0446 160 887	20 m (66 ft.)	
Interconnection cable with pre-assembled strain relief, Liquid cooled, 70 mm²		
0446 160 890	2 m (7 ft.)	
0446 160 891	5 m (16 ft.)	
0446 160 892	10 m (33 ft.)	
0446 160 893	15 m (49 ft.)	
0446 160 894	25 m (82 ft.)	
0446 160 895	35 m (115 ft.)	
Interconnection cable with pre-assembled strain relief, Air cooled, 95 mm²		

ACCESSORIES

0446 160 980	2 m (7 ft.)	
0446 160 981	5 m (16 ft.)	
0446 160 982	10 m (33 ft.)	
0446 160 983	15 m (49 ft.)	
0446 160 984	25 m (82 ft.)	
0446 160 985	35 m (115 ft.)	
Interconnection cable with pre-assembled strain relief, Liquid cooled, 70 mm²		
0446 160 990	2 m (7 ft.)	
0446 160 991	5 m (16 ft.)	
0446 160 992	10 m (33 ft.)	
0446 160 993	15 m (49 ft.)	
0446 160 994	25 m (82 ft.)	
0446 160 995	35 m (115 ft.)	
GTAW torches		
0700 300 539	TXH™ 151 V, OKC 50, 4 m	
0700 300 545	TXH™ 151 V, OKC 50, 8 m	
0700 300 553	TXH™ 201 V, OKC 50, 4 m	
0700 300 556	TXH™ 201 V, OKC 50, 8 m	
Arc air torches		
0468 253 880	Flair 600 incl monocable 2.5 m	
0468 253 016	Torch only	
0468 253 015	Monocable only	
0468 253 881	Flair 1600 incl monocable 2.5 m	
0468 253 036	Torch only	
0468 253 035	Monocable only	



A WORLD OF PRODUCTS AND SOLUTIONS.



For contact information visit esab.com

ESAB Corporation, 2800 Airport Road Denton, TX 76207, USA, Phone +1 800 378 8123

manuals.esab.com

